

MQ15-X-Power female 90° right, with cable

PUR 6x1.5 bk UL/CSA+drag chain 40m

Female 90°

MQ15, 6-pole

without cable sleeves

Plastic housings with good resistance against chemicals and oils.

The resistance to aggressive media should be individually tested for your application. Further details on request.

Further cable lengths on request.

[Link to Product](#)**Illustration**

1	black 1
2	black 2
3	black 3
PE	green/yellow
A	black 4
B	black 5

Product may differ from Image

Form

Form P8131

General data

Mounting method	inserted, tightened
Material (contact carrier)	PA
Material (contact)	Copper alloy
Material (contact surface)	Ag
Pollution Degree	3
Stripping length (jacket)	30 mm
Temperature range	-25...+80 °C, depending on cable quality

Cables

Cable number	P84
No./diameter of wires	6 × 1.5 mm ²
Wire isolation	TPM (bk num, gnye)
C-track properties	5 Mio.
Jacket Color	black
Material (jacket)	PUR (UL)
Outer Ø	9.0 mm ±5%
Bend radius (moving)	6.8 × outer-Ø
Temperature range (fixed)	-50...+80 °C
Temperature range (mobile)	-20...+70 °C
Cable identification	P84
Material (wire)	Cu wire, bare
Diameter (core)	6 × 1.5 mm ²
Shield	no
Material (jacket)	PUR
Outer-Ø (jacket)	9.0 mm ±5%
Color (jacket)	black
thermal resistance	flame retardant
Nominal voltage	1000 V AC
Test voltage	4000 V
Temperature range (fixed)	-50...+80 °C
Temperature range (mobile)	-20...+70 °C
Bend radius (fixed)	4 × outer-Ø
Bend radius (moving)	6.8 × outer-Ø
Traversing distance (C-track)	max. 5 m (horizontal)
Travel speed (C-track)	max. 3 m/s
Acceleration (C-track)	max. 5 m/s ²
Torsion stress	±15 °/m

Technical Data

Operating voltage	max. 600 V AC (Power); max. 63 V AC/DC (Signal)
Rated surge voltage	4.0 kV
Operating current per contact	max. 13 A (Power); max. 10 A (Signal)
Material group	IEC 60664-1, category I
No. of poles	6
Configuration	fully used
LED display	no
Locking of ports	Quick connection, 1/4 turn
Protection	IP67 inserted and tightened (EN 60529)

Material	Flame retardant plastic acc. to (UL 94)
Mating cycles	≥ 500

Commercial data

country of origin	DE
customs tariff number	85444290
EAN	4048879687812
eClass	27279218
Packaging unit	1

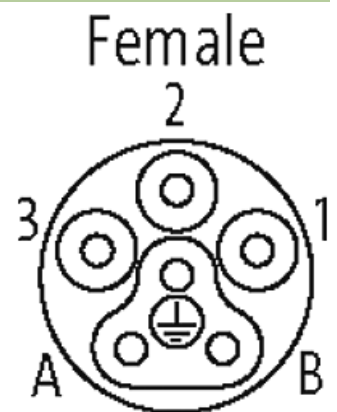
Sketch

Product may differ from Image